

User Manual

Swing Gate Opener

Applicable Models: ZK-SW300DC

Date: July 2022

Doc Version: 1.2

English

Thank you for choosing our product. Please read the instructions carefully before operation. Follow these instructions to ensure that the product is functioning properly. The images shown in this manual are for illustrative purposes only.



For further details, please visit our Company's website
www.zkteco.com.

Copyright © 2022 ZKTECO CO., LTD. All rights reserved.

Without the prior written consent of ZKTeco, no portion of this manual can be copied or forwarded in any way or form. All parts of this manual belong to ZKTeco and its subsidiaries (hereinafter the "Company" or "ZKTeco").

Trademark

ZKTeco is a registered trademark of ZKTeco. Other trademarks involved in this manual are owned by their respective owners.

Disclaimer

This manual contains information on the operation and maintenance of the ZKTeco equipment. The copyright in all the documents, drawings, etc. in relation to the ZKTeco supplied equipment vests in and is the property of ZKTeco. The contents hereof should not be used or shared by the receiver with any third party without express written permission of ZKTeco.

The contents of this manual must be read as a whole before starting the operation and maintenance of the supplied equipment. If any of the content(s) of the manual seems unclear or incomplete, please contact ZKTeco before starting the operation and maintenance of the said equipment.

It is an essential pre-requisite for the satisfactory operation and maintenance that the operating and maintenance personnel are fully familiar with the design and that the said personnel have received thorough training in operating and maintaining the machine/unit/equipment. It is further essential for the safe operation of the machine/unit/equipment that personnel has read, understood and followed the safety instructions contained in the manual.

In case of any conflict between terms and conditions of this manual and the contract specifications, drawings, instruction sheets or any other contract-related documents, the contract conditions/documents shall prevail. The contract specific conditions/documents shall apply in priority.

ZKTeco offers no warranty, guarantee or representation regarding the completeness of any information contained in this manual or any of the amendments made thereto. ZKTeco does not extend the warranty of any kind, including, without limitation, any warranty of design, merchantability or fitness for a particular purpose.

ZKTeco does not assume responsibility for any errors or omissions in the information or documents which are referenced by or linked to this manual. The entire risk as to the results and performance obtained from using the information is assumed by the user.

ZKTeco in no event shall be liable to the user or any third party for any incidental, consequential, indirect, special, or exemplary damages, including, without limitation, loss of business, loss of profits, business interruption, loss of business information or any pecuniary loss, arising out of, in connection with, or

relating to the use of the information contained in or referenced by this manual, even if ZKTeco has been advised of the possibility of such damages.

This manual and the information contained therein may include technical, other inaccuracies or typographical errors. ZKTeco periodically changes the information herein which will be incorporated into new additions/amendments to the manual. ZKTeco reserves the right to add, delete, amend or modify the information contained in the manual from time to time in the form of circulars, letters, notes, etc. for better operation and safety of the machine/unit/equipment. The said additions or amendments are meant for improvement /better operations of the machine/unit/equipment and such amendments shall not give any right to claim any compensation or damages under any circumstances.

ZKTeco shall in no way be responsible (i) in case the machine/unit/equipment malfunctions due to any non-compliance of the instructions contained in this manual (ii) in case of operation of the machine/unit/equipment beyond the rate limits (iii) in case of operation of the machine and equipment in conditions different from the prescribed conditions of the manual.

The product will be updated from time to time without prior notice. The latest operation procedures and relevant documents are available on <http://www.zkteco.com>

If there is any issue related to the product, please contact us.

ZKTeco Headquarters

Address ZKTeco Industrial Park, No. 32, Industrial Road,
Tangxia Town, Dongguan, China.

Phone +86 769 - 82109991

Fax +86 755 - 89602394

For business-related queries, please write to us at: sales@zkteco.com.

To know more about our global branches, visit www.zkteco.com.

About the Company

ZKTeco is one of the world's largest manufacturer of RFID and Biometric (Fingerprint, Facial, Finger-vein) readers. Product offerings include Access Control readers and panels, Near & Far-range Facial Recognition Cameras, Elevator/floor access controllers, Turnstiles, License Plate Recognition (LPR) gate controllers and Consumer products including battery-operated fingerprint and face-reader Door Locks. Our security solutions are multi-lingual and localized in over 18 different languages. At the ZKTeco state-of-the-art 700,000 square foot ISO9001-certified manufacturing facility, we control manufacturing, product design, component assembly, and logistics/shipping, all under one roof.

The founders of ZKTeco have been determined for independent research and development of biometric verification procedures and the productization of biometric verification SDK, which was initially widely applied in PC security and identity authentication fields. With the continuous enhancement of the development and plenty of market applications, the team has gradually constructed an identity authentication ecosystem and smart security ecosystem, which are based on biometric verification techniques. With years of experience in the industrialization of biometric verifications, ZKTeco was officially established in 2007 and now has been one of the globally leading enterprises in the biometric verification industry owning various patents and being selected as the National High-tech Enterprise for 6 consecutive years. Its products are protected by intellectual property rights.

About the Manual

This manual introduces the operations of **Swing Gate Opener**.

All figures displayed are for illustration purposes only. Figures in this manual may not be exactly consistent with the actual products.

Features and parameters with ★ are not available in all devices.

Document Conventions

Conventions used in this manual are listed below:

GUI Conventions

For Software	
Convention	Description
Bold font	Used to identify software interface names e.g. OK, Confirm, Cancel .
>	Multi-level menus are separated by these brackets. For example, File > Create > Folder.
For Device	
Convention	Description
<>	Button or key names for devices. For example, press <OK>.
[]	Window names, menu items, data table, and field names are inside square brackets. For example, pop up the [New User] window.
/	Multi-level menus are separated by forwarding slashes. For example, [File/Create/Folder].

Symbols





Convention	Description
	This represents a note that needs to pay more attention to.
	The general information which helps in performing the operations faster.
	The information which is significant.
	Care taken to avoid danger or mistakes.
	The statement or event that warns of something or that serves as a cautionary example.

Table of Contents

1	SAFETY INSTRUCTION.....	6
2	PARTS LIST	8
2.1	PARTS LIST (STANDARD CONFIGURATION).....	8
2.2	PARTS LIST (OPTIONAL)	9
3	TECHNICAL PARAMETERS.....	10
4	INSTALLATION.....	11
4.1	INSTALLATION DRAWING.....	11
4.2	TOOLS NEEDED FOR STANDARD INSTALLATION	12
4.3	CABLE LIST	12
4.4	SIZE OF THE MAIN MACHINE AND THE MOUNTING BRACKET	13
4.4.1	SIZE OF THE MAIN MACHINE.....	13
4.4.2	SIZE OF THE MOUNTING BRACKET	13
4.5	INSTALLATION STEPS.....	14
4.5.1	PREPARATION BEFORE MAIN MACHINE INSTALLATION.....	14
4.5.2	ACCESSORY INSTALLATION.....	14
4.5.3	MAIN MACHINE INSTALLATION.....	16
4.5.4	SIZE OF CONTROL BOX	18
5	WIRING AND DEBUGGING.....	20
5.1	WIRING INSTRUCTIONS.....	20
5.2	CONTROL BOARD DRAWING AND INSTRUCTIONS	21
5.3	DIGITAL DISPLAY INSTRUCTION	22
5.4	TRAVEL SETTING (VERY IMPORTANT).....	22
5.5	TRIMMERS SETTING.....	23
5.6	LEARNING TRANSMITTER & DELETE TRANSMITTER	23
5.6.1	LEARNING TRANSMITTER.....	23
5.6.2	DELETE TRANSMITTER.....	24
5.6.3	SPECIAL TRANSMITTER KEY-BUTTON	24
5.7	CONTROL BOARD SETTINGS	24
5.7.1	BASE MENU.....	24
5.7.2	BASE MENU INSTRUCTION.....	26
5.7.3	ADVANCED MENU.....	28
5.7.4	ADVANCED MENU INSTRUCTION.....	29
6	MAINTENANCE	30
7	TROUBLESHOOTING.....	30

Dear users,

Thank you for choosing this product. Please read the manual carefully before assembling and using it. Please do not leave out the manual if you send this product to a third party.

1 Safety Instruction











- Please read this manual carefully before installation, in which involves with important information about installation, using, maintenance and safety.
- Any undefined operations under this manual is not allowed, incorrect using may damage the product even causing the injuries or property losses.
- To consider the possible danger during the installation or using process of swing gate operator, installation must strictly comply with the construction standard and electrical operating procedure.
- Before installation, please make sure that the power voltage being used matches with the supply voltage of this product. Please check if the leakage protection switch is installed and the grounding system is correct.
- Please check if additional equipments or materials are required to meet the specific requirements.
- The disposal of packaging material must be complying with the local regulation.
- Please do not change any parts except for those defined under this manual. Any undefined changes may cause the malfunction. Any damages to the product arising therefrom shall be beyond the liability of the company.
- Please do not leak water or any liquid into the controller or any other open devices. Please disconnect the power immediately if any mentioned cases happened.
- Please keep this product away from heat and open fire. Or it may damage the components; cause the failure or other hazards.
- Please make sure there is no vehicles, passengers and objects passing through while the swing gate is moving.
- Anti-clip equipment like infrared protection switch must be installed to avoid injuries to person and property losses. The company shall not be liable for any damage or accident arising therefrom.

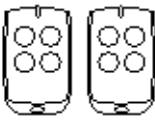
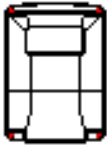
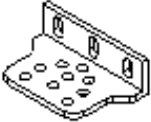
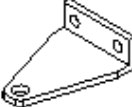

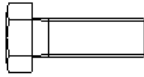
- The installation, using and maintenance of this product must be carried out by professionals.
- Children are not allowed be touch the control devices or remote transmitters.
- A warning sign must be placed somewhere on the swing gate according to the national standard.
- Please keep this instruction properly for future reference.

2 Parts List

2.1 Parts List (Standard Configuration)

No.1	Picture	Name	Quantity
1		Main Machine	2
2		Manual Release Keys	2
3		Remote Controls	2
4		Control Box	1
5		Wall Bracket	4
6		Front Mounting Bracket	2
7		Connecting Bracket	2
8		Screw M8 * 25	4
9		Mounting Screw (short)	2
10		Screw M8 * 25	2
11		Self-locking Nut M8	8
12		Limit Stopper	1

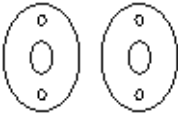
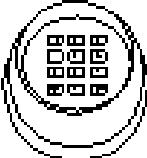
2.2 Parts List (Optional)

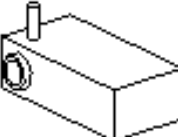
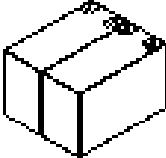
No.1	Picture	Name	Quantity
1		Infrared Sensor	1
2		Wireless Keypad	1
3		Alarm Lamp	1
4		Electric Lock	1
5		Storage Battery	2

3 Technical Parameters

Model	ZK-SW300DC
Power Requirements	220V/50Hz; 110V/60Hz
Operating Voltage	24V 40W*2
Operating Temperature	-20°C to +70°C
Gate Moving Speed	18 to 22s/90°
Max. single-leaf Weight	300Kg
Max. single-leaf Length	2.5m
Max. piston Stroke	0.32m
Max. force	2600N
Remote Control Distance	≥30m
Remote Control Mode	Single/Four button mode
Storage Battery (Optional)	DC24V (4.5Ah or 9Ah)
Safety Detection	Over Current Detection
Working Noise	≤58dB
Working Duty	S2, 30min
Recording of up Remote Controls	25
Remote Frequency	433.92 MHz
Dimension (L*W*H)	Main Machine (Max): 1037.5*100*85.7(mm) Control Box (without built-in battery): 210*299*88(mm) Control Box (with built-in battery): 210*299*133(mm)
Dimension with packing (L*W*H)	825*195*265(mm)
Net Weight	10.12Kg
Weight with Packaging	14Kg
Gate Limit Type	Magnetic

Ingress Protection	IP23 (With drain hole)
Warranty	1 year

4 Installation

The ZK-SW300DC swing gate opener is suitable for single leaf gate weighing less than 300kg and is measured less than 2.5m in length. The screw rod transmission is combined with planetary transmission in the drive mode. For security purpose, the gate opener must be put inside the enclosure or yard.

4.1 Installation Drawing

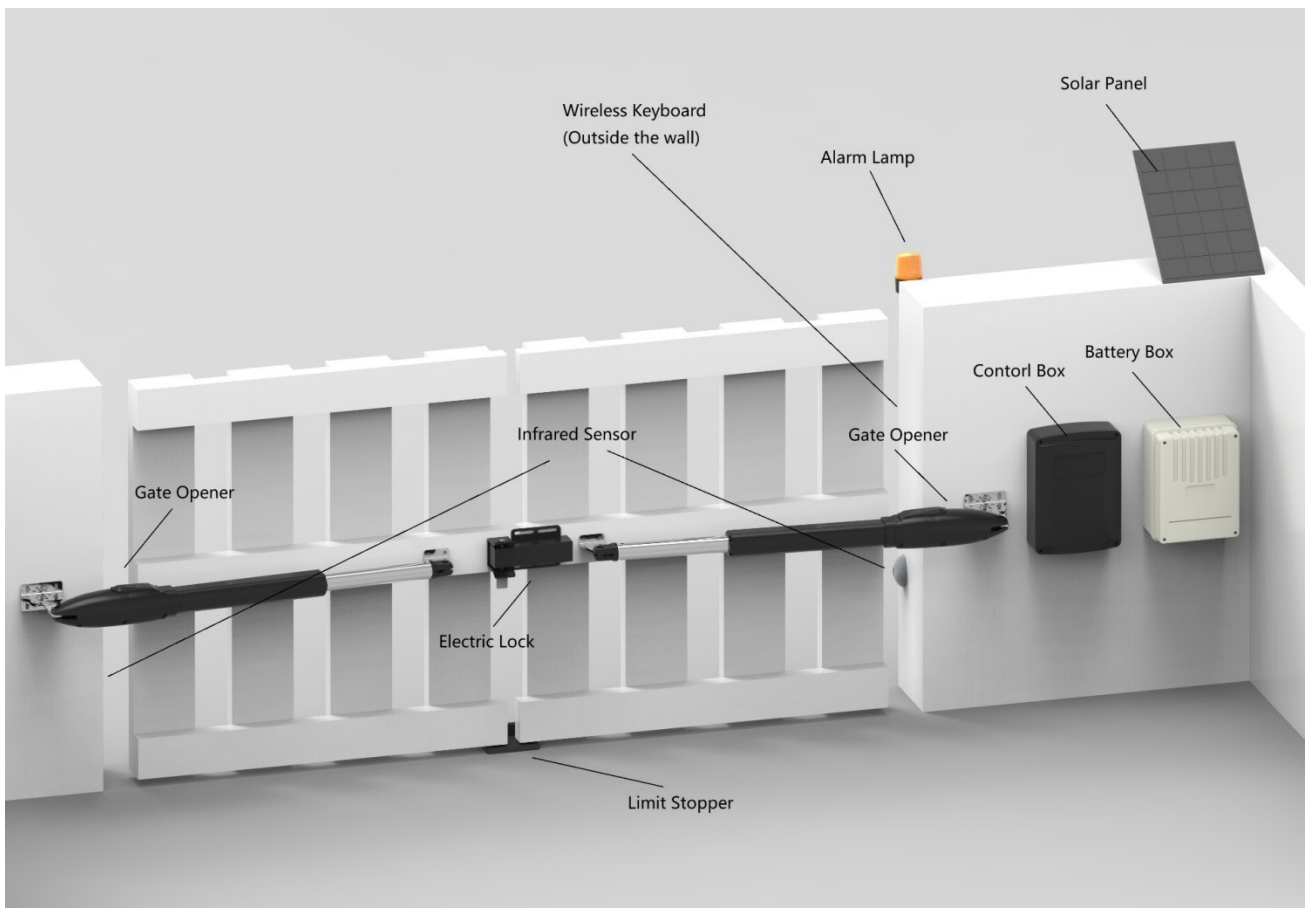
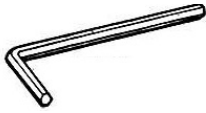
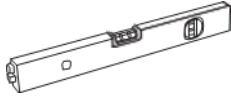

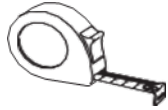





Figure 1

4.2 Tools Needed for Standard Installation

	No.6 Allen Wrench		Spirit Level
	Slotted Screwdriver		Tape
	Phillips Screwdriver		Adjustable Wrench X 2
	Hatching Pen		



Note: The cables must be suitable for outdoor use.

4.3 Cable List

No.	Cable Application	Cable Material	Max. Length
1	Cable of 220V control box's power supply	3 * 2.5mm ² (>30m) 3 * 1.5mm ² (<30m)	Unlimited
2	Cable of gate opener's power supply	2 * 1.5mm ²	15m
3	Cable of infrared sensor	2 * 0.5mm ²	10m
4	Cable of alarm lamp	2 * 0.5mm ²	10m
5	Cable of electric lock	2 * 0.5mm ²	10m
6	Extension cable of storage battery	2 * 1.5mm ²	10m
7	Cable of solar power	2 * 1.5mm ²	10m

Due to different installation environments, installer need to prepare power cables for control box and gate openers.



Note: Cable outlet should be downward to prevent rainwater from entering wire along the cable.

4.4 Size of the Main Machine and the Mounting Bracket

4.4.1 Size of the Main Machine

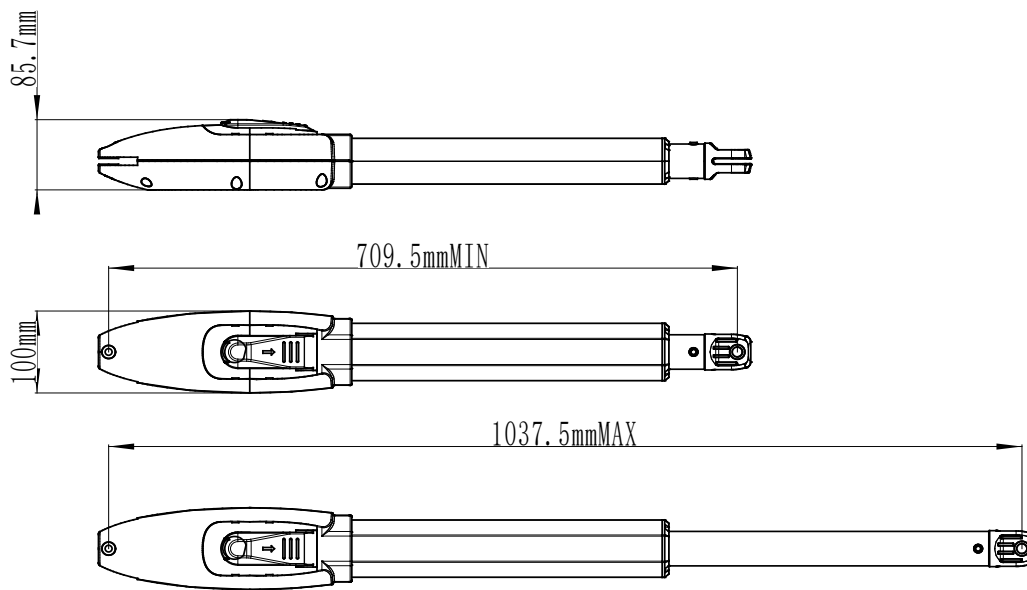
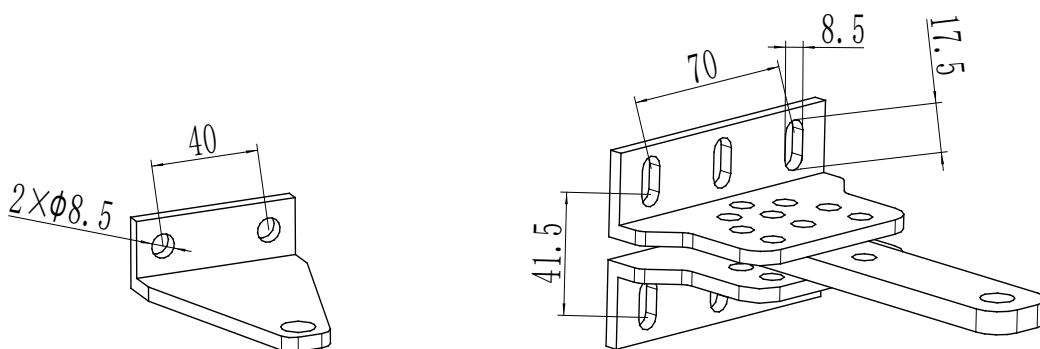

Figure 2

4.4.2 Size of the Mounting Bracket



Front mounting bracket

Wall bracket

Figure 3

4.5 Installation Steps

4.5.1 Preparation before Main Machine Installation

1. Before installing the door opener, double-check that that the doors were installed properly, and that the door can be manually operated, as well as the door safety stopper can effectively stop the door from moving.
2. Keep a 45 to 50 mm gap between the bottom of the door and the ground when installing the electric lock. Leave a 20mm gap between the bottom of the door and the ground if an electric lock isn't needed.
3. The recommended mounting height for the two main machines is around 300 to 800 mm above the ground, and make sure that there are reliable fixed points for mounting brackets.

- **Cable buries**

- Please use two PVC pipes to bury the motor and power cables, as well as the control cables, separately to ensure normal operation of the door opener and to protect the cable from damage. The motor and power cables are routed via one PVC pipe, while the control cables are routed through the other.

- **Mounting brackets fixing**

To install the ZK-SW300DC main machines firmly, it is recommended to use the expansion screws to fix the mounting brackets.

4.5.2 Accessory Installation

1. Before installing the main machines, please install the wall bracket first, then the connecting bracket, and finally the front mounting bracket on the door.

Note: Please detect the gradient before fixing to ensure that the front mounting bracket and the connecting bracket are in the same level.

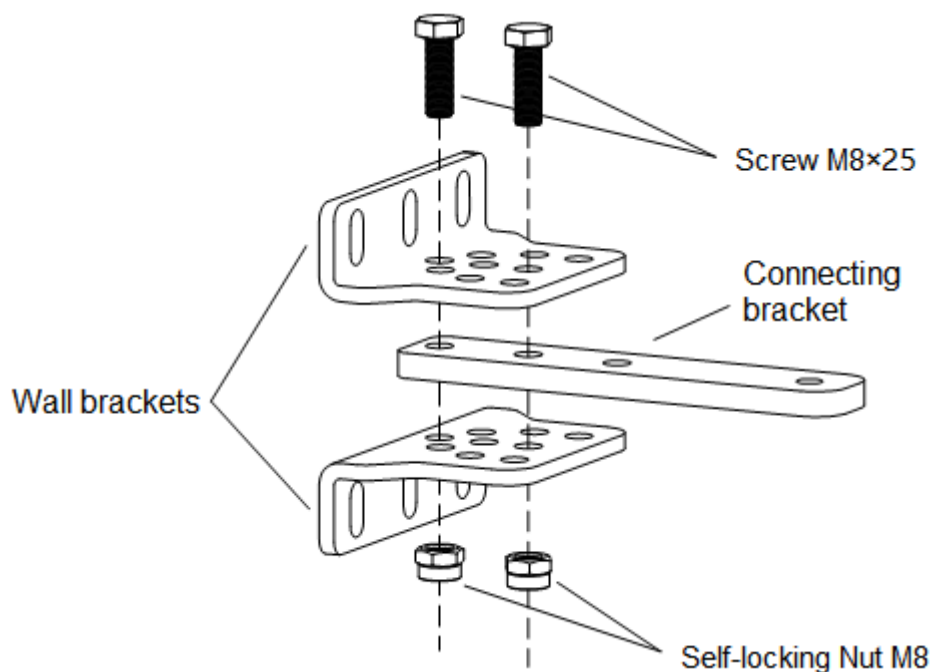

Figure 4

2. The connecting bracket and the wall bracket can be connected according to different conditions, please refer to figure 5.

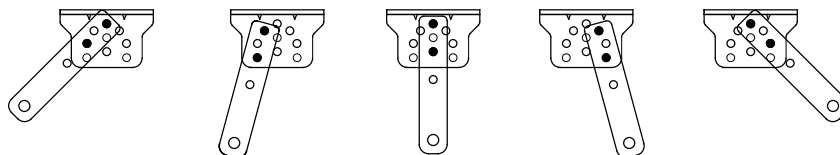

Figure 5

3. Due to the various installation environment, users should arrange power cords for the control box and the main equipment themselves. The power supply cable for the control box should have more than three cores, whereas the motor cable should only have two. If users need to install external accessories such as an electric lock, infrared sensor, alarm lamp, or external button switch, increase the embedded cables accordingly. Make sure the sectional diameter of the electric lock cable is over 1.5mm², and the sectional diameter of the other cables is over 0.5mm. Users should determine the cable length based on their installation circumstances.

Note: The outlet on the PVC pipe should be downward to avoid the rainwater following into the pipe along the cable.

4. Please unlock the two main machines before proceeding with the installation.

Method of unlocking: Open the manual release cover, then enter the manual release key, and rotate the key until it's released, as indicated in Figure 6, then turn on the telescopic arm to see how easily it may be stretched.

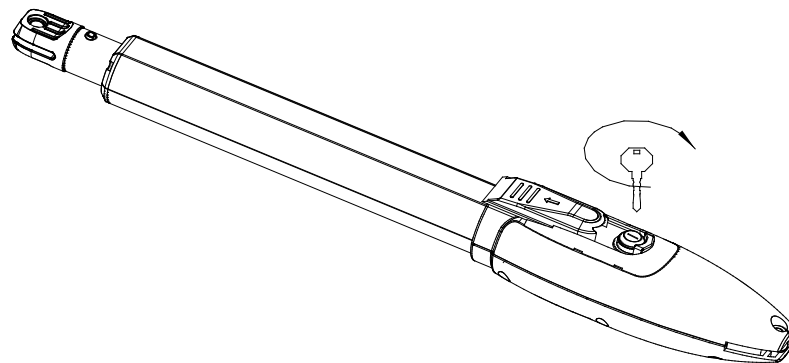

Figure 6

4.5.3 Main Machine Installation

Please refer to Figure 7 to fix the tail of the main machine and the connecting bracket with the installation screws, and then manually adjust the telescopic arm to its appropriate length. Finally fix the telescopic arm connector and the front mounting bracket with the installation screws.

Pull the door open after installation to ensure that the travel is flexible and not jammed.

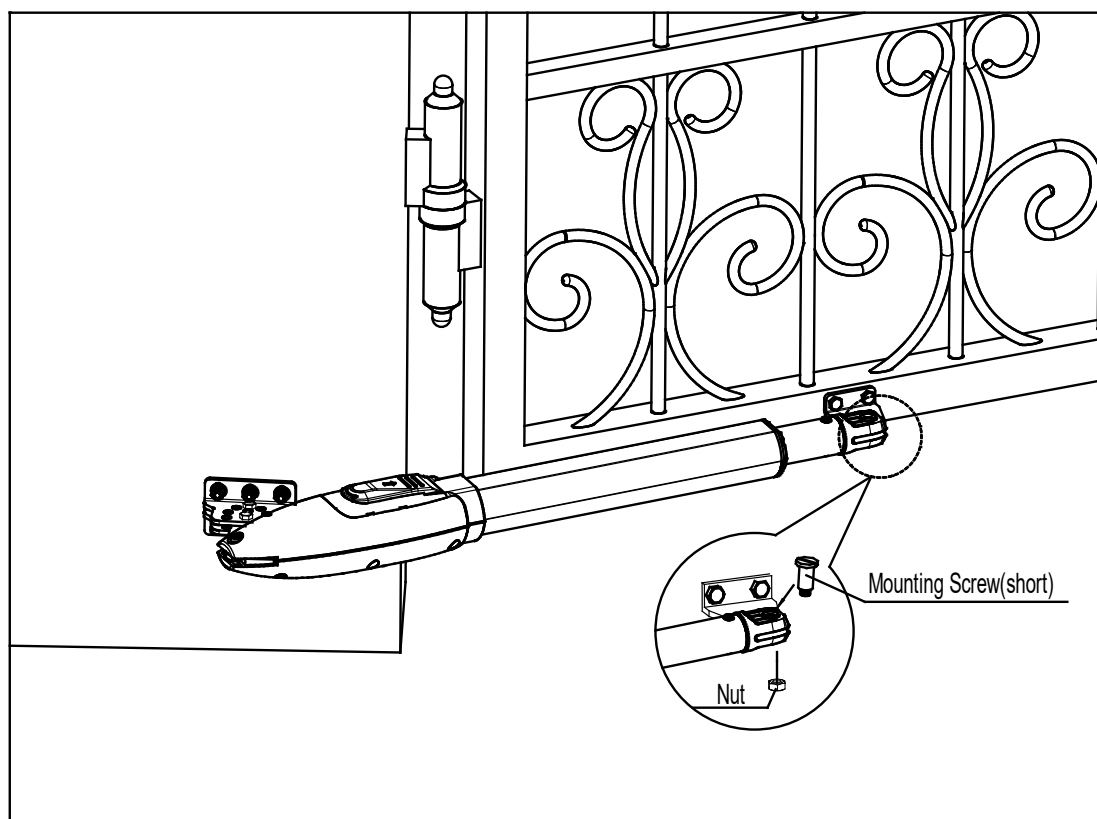

Figure 7

Installation direction: door opens inward

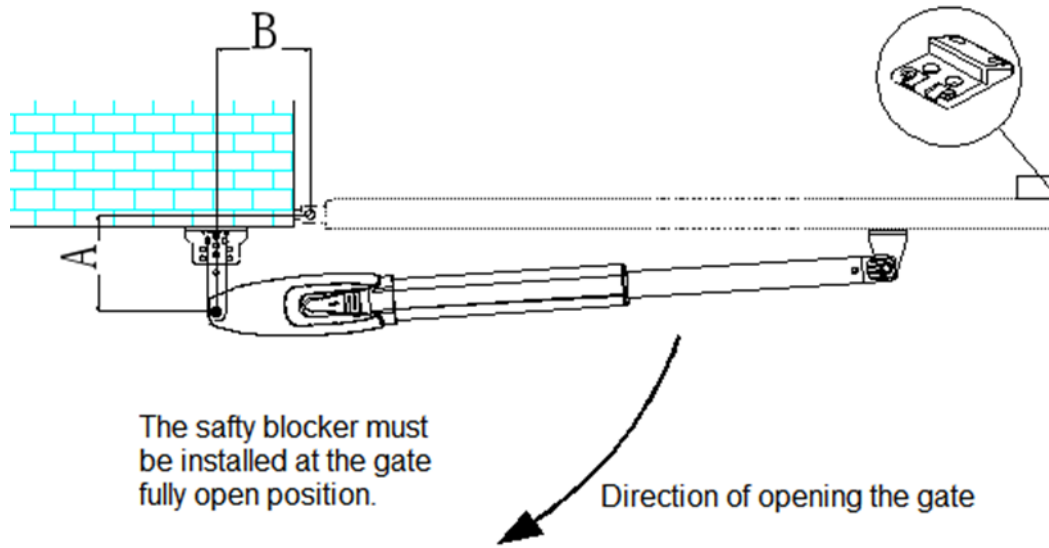

Figure 8

A \ B	100mm	120mm	140mm	160mm	180mm	200mm
100mm	102°	101°	99°	98°	97°	97°
120mm	111°	108°	106°	104°	103°	99°
140mm	118°	115°	112°	102°	93°	96°
160mm	117°	107°	98°	91°		
180mm	103°	96°	90°			
200mm	94°					

Installation direction: door opens outward

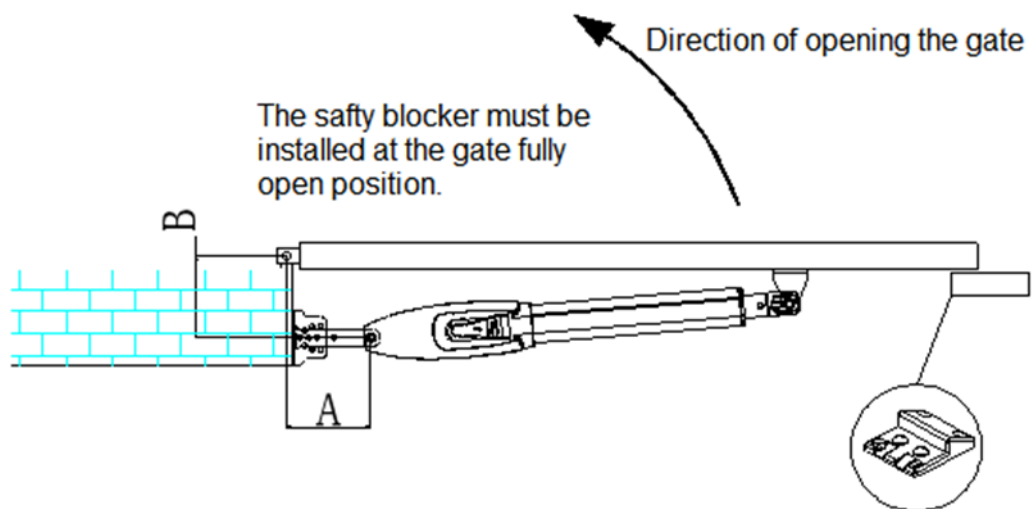

Figure 9

A \ B	100mm	120mm	140mm	160mm	180mm	200mm
100mm	103°	101°	99°	98°	97°	97°
120mm	111°	108°	106°	104°	103°	96°
140mm	118°	115°	112°	102°	92°	
160mm	117°	108°	98°	91°		
180mm	103°	96°	90°			
200mm	94°					

4.5.4 Size of Control Box

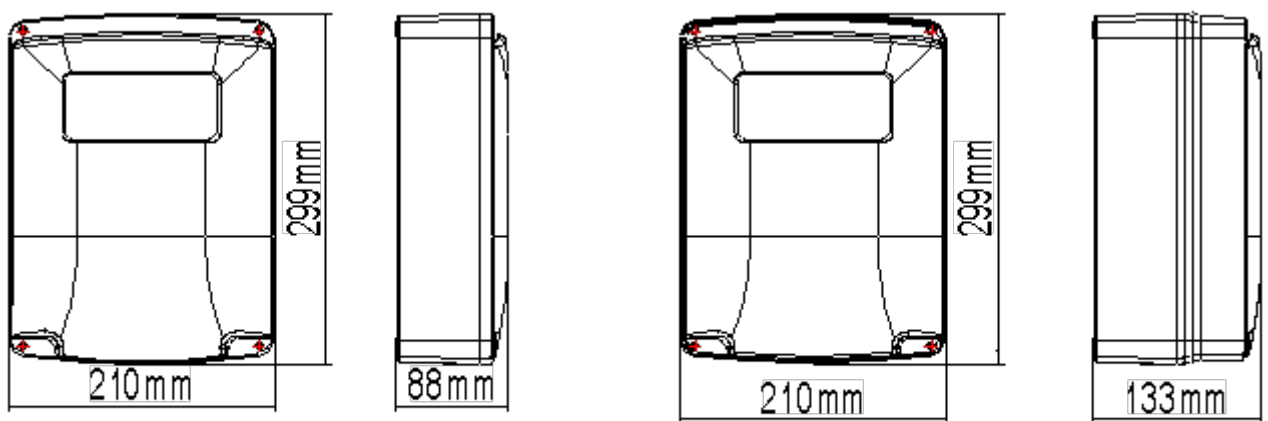

Figure 10



Warning

- Please install a gate stopper at the open limit position when the door opens outward to prevent the gate from running beyond its travel. This will ensure the safety and protection of the machines. Meanwhile, to enable the 2 swings to close to its accurate limit position, please install a limit stopper at the close limit position (as shown in figure 9). Similarly, when the door opens inward, please install a limit stopper at the close limit position (as shown in figure 8).
- Before installing the main machine, please make sure the main machine and components are in good mechanical performance and the door can be manually operated flexibly.
- One control unit can optionally drive one or two main machines.
- Earth leakage circuit breaker must be installed on where the gate movement can be seen, and the minimum mounting height for the control box should be over 1.5m to avoid being touched by kids.

- After installation, please check whether the mechanical property is good or not, whether gate movement is flexible or not after unlocking, and whether the infrared sensor (optional) is installed correctly and effectively.

5 Wiring and Debugging

5.1 Wiring Instructions

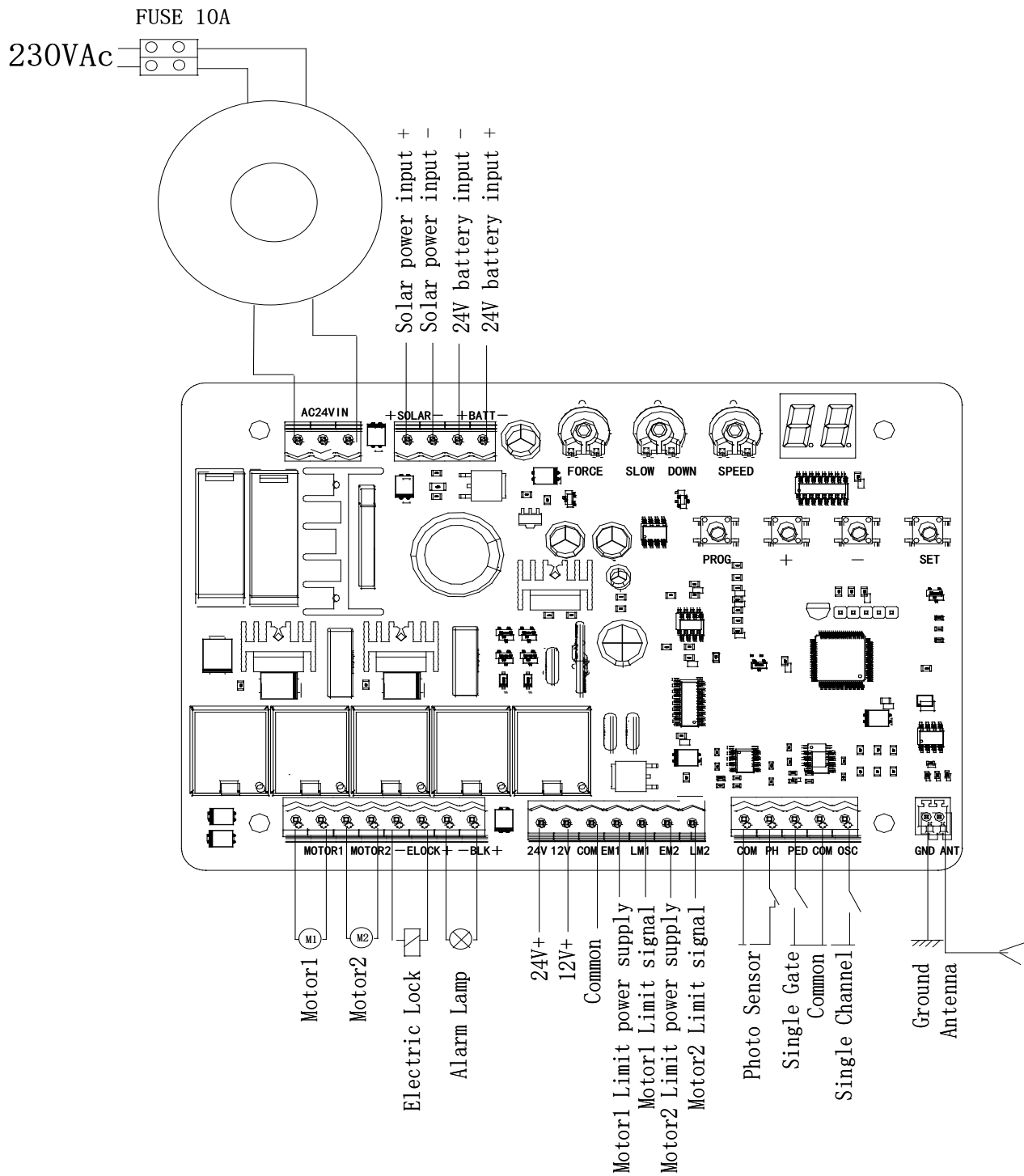

Figure 11

5.2 Control Board Drawing and Instructions

Drawing:

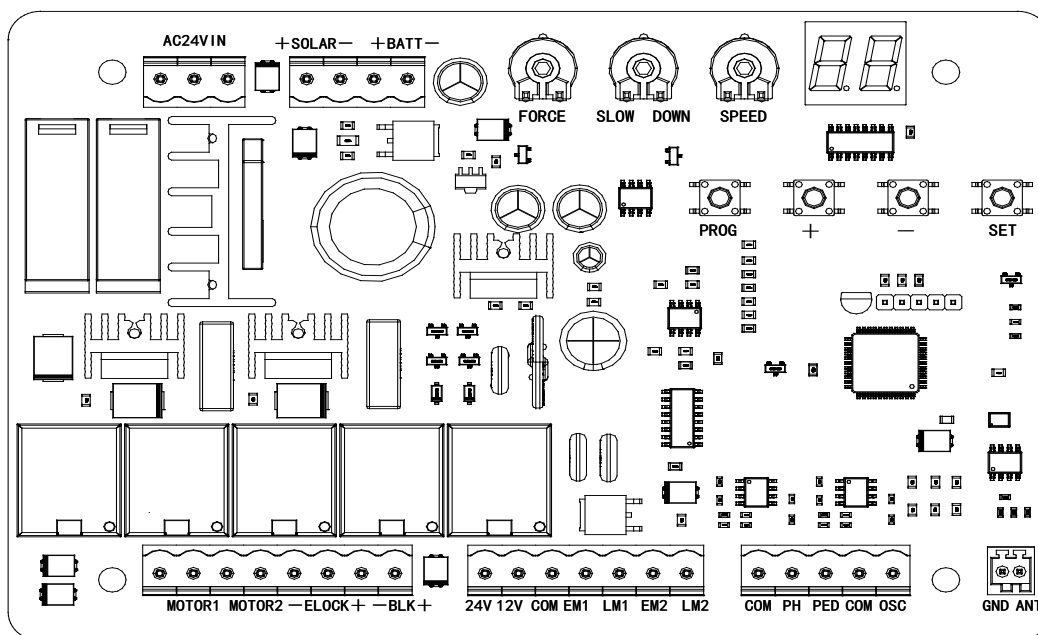
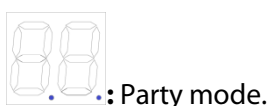
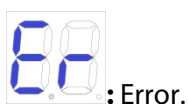
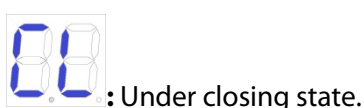
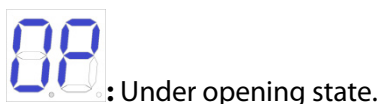

Figure 12

Terminal	Description
1. AC24VIN	24VAC power supply input
2. +SOLAR-	Solar Power Input
3. +BATT-	24V battery Input
4. FORCE	Resistance Force
5. SLOW DOWN	Slow Stop Distance
6. SPEED	Moving Speed
7. MOTOR1	Motor1 Output
8. MOTOR2	Motor2 Output
9. -ELOCK+	Electric Lock Output
10. -BLK+	Alarm Lamp Output (Note: Pay attention to the negative and positive.)
11. +24V	24V Output Positive
12. +12V	12V Output Positive (No output under dormant state)
13. EM1	Motor1 Limits The Power Input
14. LM1	Motor1 Limits Signal Input
15. EM2	Motor2 Limits The Power Input
16. LM2	Motor2 Limits Signal Input
17. PH	Photo sensor Input Active
18. PED	Single Gate/Pedestrian Mode Input Active
19. OSC	Single Channel Input Active
20. ANT	Antenna
21. COM	Common

5.3 Digital Display Instruction

Users can verify the status of the gate opener's operation on the control board's digital screen when it is functioning.



5.4 Travel Setting (VERY IMPORTANT)

Fully open both sides of the gate and lock the clutch, and then long press the "-" button on the control board until the digital screen shows "SU". At that time, the gate will firstly run towards the closing direction and stop, and then the gate will automatically open. When the two swing gates are fully open, the gates will automatically close for the second time, and the travel setting will be completed when the gates are closed. If the distance of starting slow speed of gate is not appropriate, adjust the "SLOW DOWN" button to revise the distance.

Note:

- Please increase the resistance force if it suddenly stops during the travel setting.
- Please properly reduce the resistance force if the gate has not stopped blocking when it meets the blocker during the travel setting.

- After changing the "SPEED" trimmer, the installer must reapply the travel setting.

5.5 Trimmers Setting

Obstacle Sensibility Trimmer

To adjust the sensitivity of obstacle -- clockwise to increase, counterclockwise to reduce the sensitivity of obstacle. If there are environmental effects, such as heavy winds, adjust the trimmer according to environment.

Slow Speed Distance Trimmer

To adjust slow speed distance -- clockwise to increase, counterclockwise to decrease slow speed distance. Please do not set very short slow speed distance, to avoid the gate collision.

Gate Moving Speed Trimmer

To adjust gate moving speed -- clockwise to accelerate, counterclockwise to slow down. The trimmer can be adjusted to change the opening and closing travel time. This adjustment must be finished before travel setting.

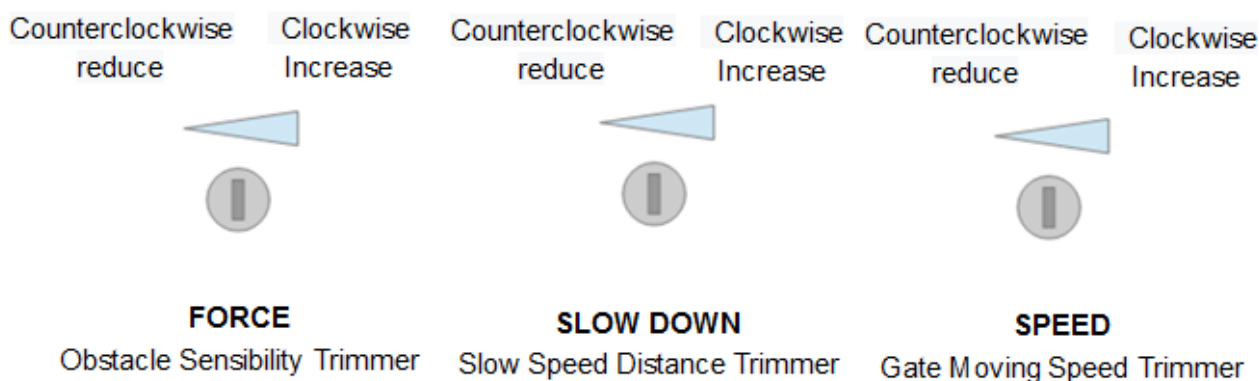

Figure 13

5.6 Learning Transmitter & Delete Transmitter

5.6.1 Learning Transmitter

Long press "+", the alarm light will keep flashing, and digital screen displays remote control mode -- "PO" -- two swing gates single channel mode; "Pd" -- single gate four channel mode; and the current number of paired remote controls. Press the button of the remote control to be learned, the digital screen will show the number of current learned remote control, then the remote control learning is completed. (The default of new paired remote control is two swing gates single channel mode).

5.6.2 Delete Transmitter

Enter into AE in the digital screen and then to choose "rE" to delete the remote controls.

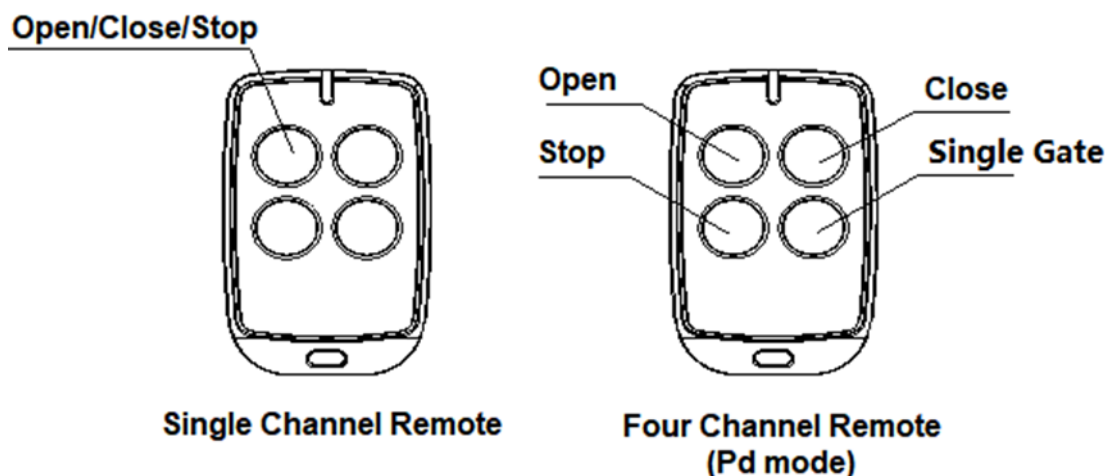

Figure 14

5.6.3 Special Transmitter Key-button

Long press the combination keys for 5S.

- A (open) + D (single gate) combination key -- enter into travel setting;
- B (close) + D (single gate) combination key -- enter/exit party mode; (Party mode: the swing gates can only be opened but cannot be closed. In party mode, the alarm light will flash for 2S when the control board receives signal.)
- C (stop) + D (single gate) combination key -- enter into remote control learning.

5.7 Control Board Settings

5.7.1 Base Menu

Press "PROG" to enter into base menu;

Digital Screen shows "NE", select other functions of this menu by "+" and "-" buttons.

Press "SET" to confirm or to enter into sub-menu.







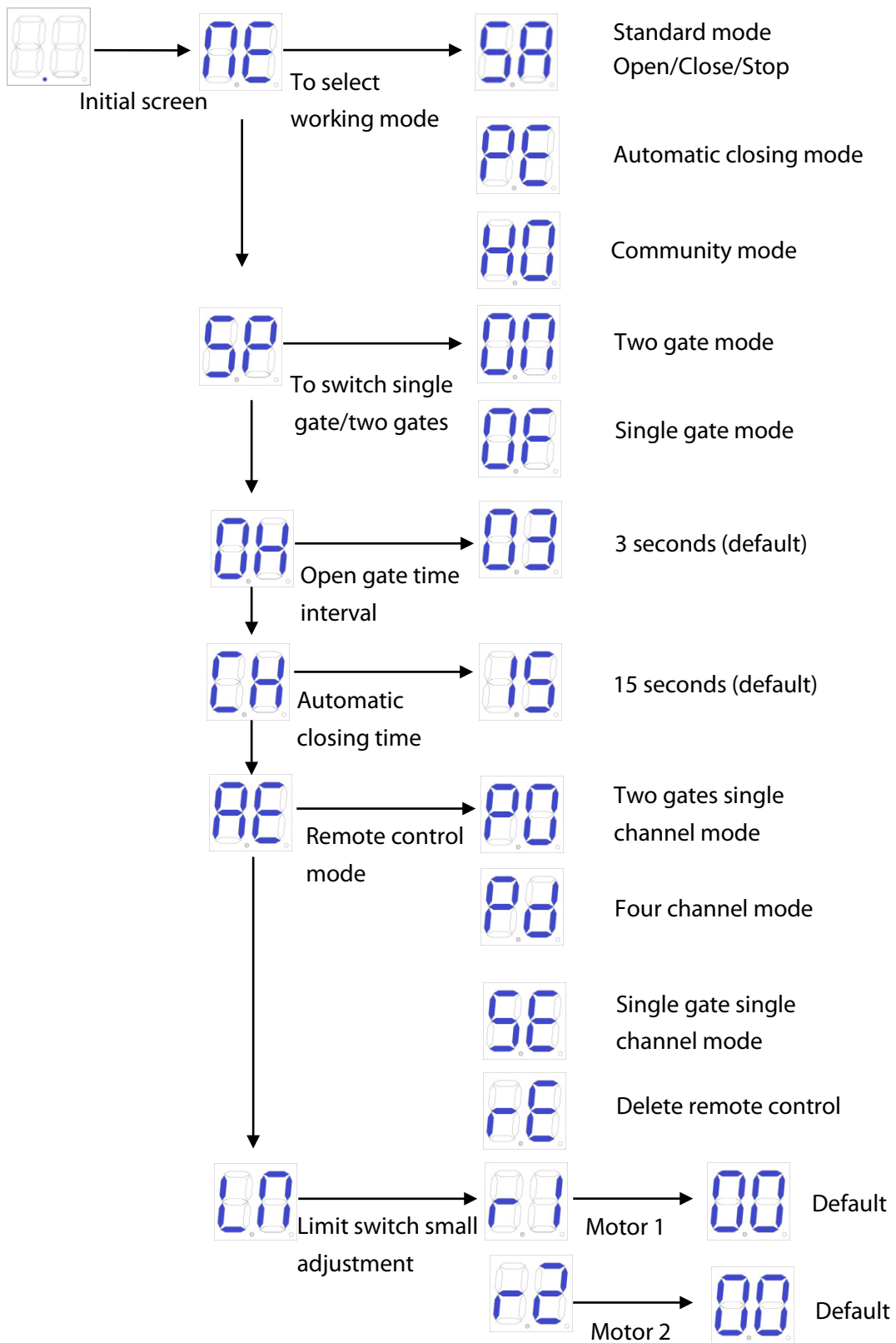

To exit menu, press "PROG".







If no command for one minute, the menu will automatically exit.

Base Menu

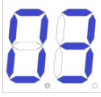
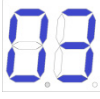
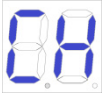

5.7.2 Base Menu Instruction

<p>Menu</p> <p>Press "PROG" to enter into base menu.</p>	<p>Option</p> <p>Press "+" (up) or "-" (down) to select; Press "SET" to confirm.</p>	<p>Default/Attention</p>
<div style="text-align: center;">  <p>Working Mode</p> </div>	<div style="text-align: center;">  <p>Standard mode; O/C/S (Open/Close/Stop).</p> </div> <div style="text-align: center;">  <p>O/S/C standard mode with automatic closing function. When the gate opens, it will automatically close after automatic closing time. If a "close the gate" command is sent during the automatic closing time waiting time, the automatic closing function will be cancelled.</p> </div> <div style="text-align: center;">  <p>Community mode (with automatic closing function). When the gate opens, any gate command will not be responded until it closes automatically. If user sends gate command during the closing process, then the gate will reopen. If a gate command is sent during the automatic closing waiting time, this waiting time will be recalculated. If the gate is not closed completely for more than three consecutive times, the automatic closing function will be cancelled and the gate will be closed by re-sending the door closing command. Note that in community mode, the door still has the automatic closing function in case of meeting obstacles.</p> </div>	<div style="text-align: center;">  <p>Standard mode; O/C/S (Open/Close/Stop).</p> </div>
<div style="text-align: center;">  <p>Single Gate/Two Gates Switch</p> </div>	<div style="text-align: center;">  <p>Two gate mode (default).</p> </div> <div style="text-align: center;">  <p>Single gate mode.</p> </div>	<div style="text-align: center;">  <p>Two gate mode.</p> </div>

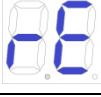
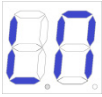
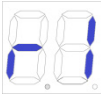
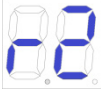
 <p>Open Gate Time Interval</p>	 <p>00-10: Open gate time interval is 0-15 seconds (default 3 seconds). If the interval shorter than 2 seconds, then the electric lock cannot be used.</p>	 3 seconds.
 <p>Automatic Closing Time</p>	 <p>Automatic closing time can be set as 15 (default), 30, 60, 90 seconds.</p>	 15 seconds.
 <p>Remote Control Mode</p>	 Two gates single channel mode.  Four channel mode.  Single gate single channel mode.  Delete all paired remote controls.	
 <p>Limit Switch Small Adjustment</p>	 <p>Increasing the value of "r1" can extend the closing limit position of gate1.</p>  <p>Increasing the value of "r2" can extend the closing limit position of gate2.</p> <p>Note: This value applies only for electronic limit. The value cannot be increased indefinitely and it is only used for small adjustment after manually set the limit switch positions.</p>	

5.7.3 Advanced Menu

Long press "PROG" 2 seconds to enter into advanced menu.

Digital Screen shows "PH", press "+" (up) or "-" (down) to select;

Short press "SET" to confirm or to enter into sub-menu.







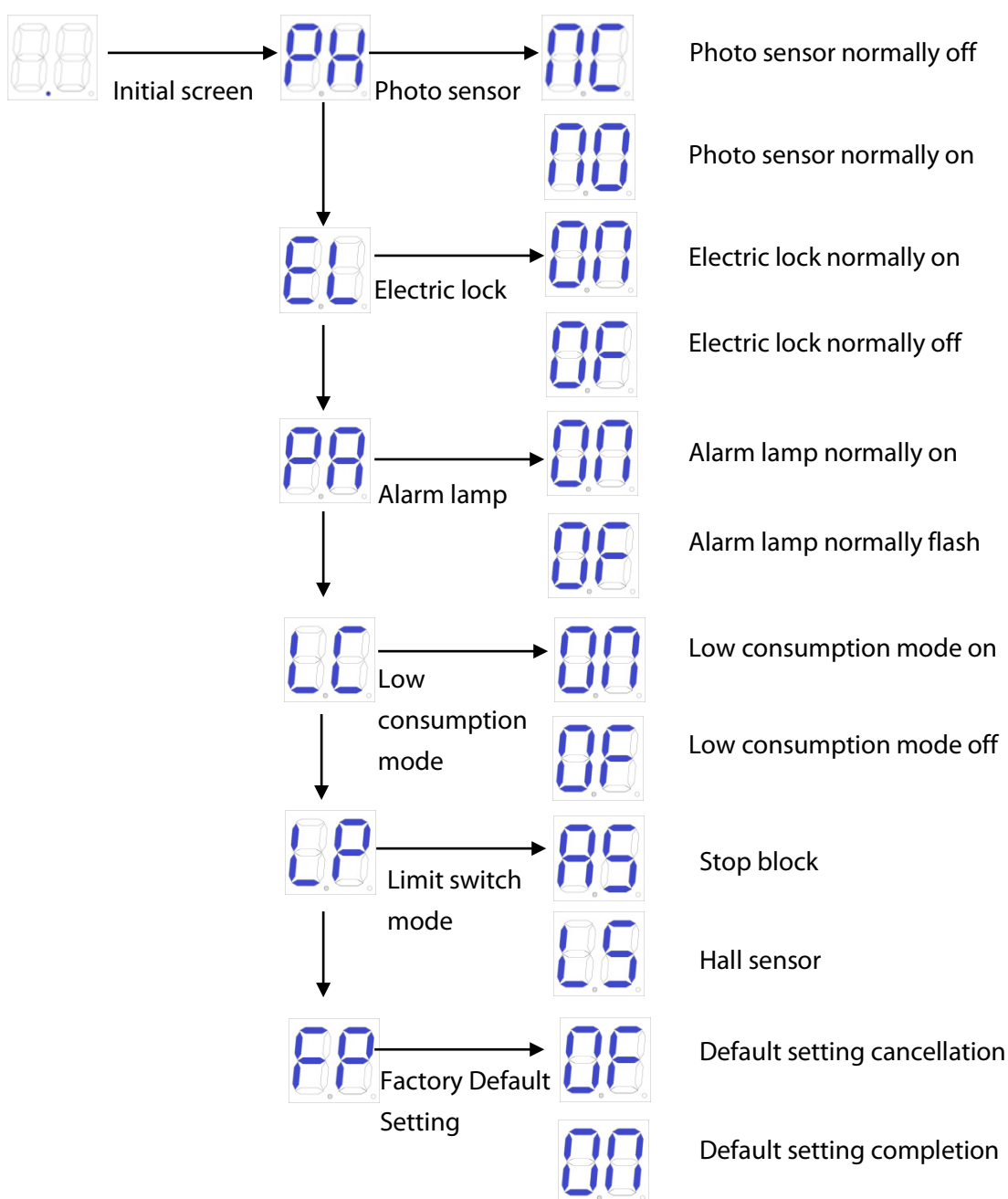













Short press "PROG" to exit.

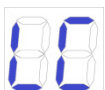



If no command for one minute, the menu will automatically exit.

Advanced Menu

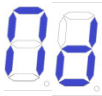
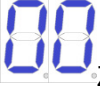

5.7.4 Advanced Menu Instruction

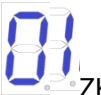
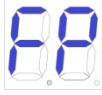
Menu Long press "PROG" 2 seconds to enter into base menu.	Option Press "+" (up) or "-" (down) to select; Press "SET" to confirm.	Default/Attention
 Photo Sensor	 N/C; photo sensor normally is off.  N/O; photo sensor normally on. (Default)	 N/O; photo sensor normally on.
 Electric Lock	 Electric lock normally is on. (Default)  Electric lock normally is off.	 Electric lock normally on.
 Alarm Lamp	 Alarm lamp normally is on. 24V power supply. (Default)  Alarm lamp normally flashes. 24V power supply.	 Alarm lamp normally is on. 24V power supply.
 Low Consumption Mode	 Low consumption mode on. The control board will automatically enter low-consumption mode after one minute when there is no operation at the initial screen. (Default)  Low consumption mode off.	 Low consumption mode on.
 Limit Switch Mode	 Stop block. (Default)  Hall sensor.	 Stop block.

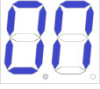
 <p>Swing Gate Open Model</p>	 ZK-SW400DC.  ZK-SW300DC. (Default)	 ZK-SW300DC.
 <p>Factory Default Setting</p>	 Cancel factory default setting.  Factory default setting completes.	

6 Maintenance

1. Check whether the gate normally operates every month.
2. For the sake of safety, each gate is suggested to be equipped with infrared protector, and regular inspection is required as well.
3. Before installation and operation of the gate opener, please read all the instructions carefully.
4. We reserve the right to change the instruction without prior notice.

7 Troubleshooting

Any troubleshooting work below, done to the motor must be completed by a licensed electrician and only whilst the power is off and the motor is unplugged!

Problems	Possible Reasons	Solutions
The gate doesn't open or close properly, and LED doesn't light.	<ol style="list-style-type: none"> 1. The power is off. 2. Fuse is burned. 3. Control board is wrongly power wired. 	<ol style="list-style-type: none"> 1. Switch on the power supply. 2. Check the fuse, change it if it burnt. 3. Re wiring according to the instructions.
The gate can open but cannot close.	<ol style="list-style-type: none"> 1. Photocell wrongly wired. 2. Photocell wrongly installed. 3. Photocell is blocked by the 	<ol style="list-style-type: none"> 1. If photocell is not installed, please make sure that there is jumper wire between IR and COM ports. If photocell is installed, please make sure the relative wirings are correct and the photocell contact is N.C.

	<p>objects.</p> <p>4. Sensitivity of obstacle is too high.</p>	<p>2. Make sure that the photocell emitter and receiver can be mutually aligned.</p> <p>3. Remove the obstacle.</p> <p>4. Reduce the sensitivity of obstacle.</p>
Remote control doesn't work.	<p>1. Battery level of the remote control is low.</p> <p>2. Remote control is not paired.</p>	<p>1. Change the remote-control battery.</p> <p>2. Re-conduct remote control learning.</p>
Press OPEN, CLOSE button, the gate doesn't run, motor has noise.	Gate moving is not smoothly.	According to the actual situation to adjust the motor or the gate.
Leakage switch tripped.	Power supply line short circuit or motor line short circuit.	Check wiring.
Remote control working distance is too short.	Signal is blocked.	Connect with an external antenna, 1.5 meters above the ground.
The gate moves to the middle position then stop or reverse.	<p>1. Motor output force is not enough.</p> <p>2. Sensitivity of obstacle is too high.</p> <p>3. Gate meets obstacle.</p>	<p>1. Check whether the transformer power is normal, if not, change the transformer.</p> <p>2. Adjust the TR2.</p> <p>3. Remove the obstacle.</p>

ZKTeco Industrial Park, No. 32, Industrial Road,

Tangxia Town, Dongguan, China.

Phone : +86 769 - 82109991

Fax : +86 755 - 89602394

www.zkteco.com

